

[www.roll-packaging.com](http://www.roll-packaging.com)

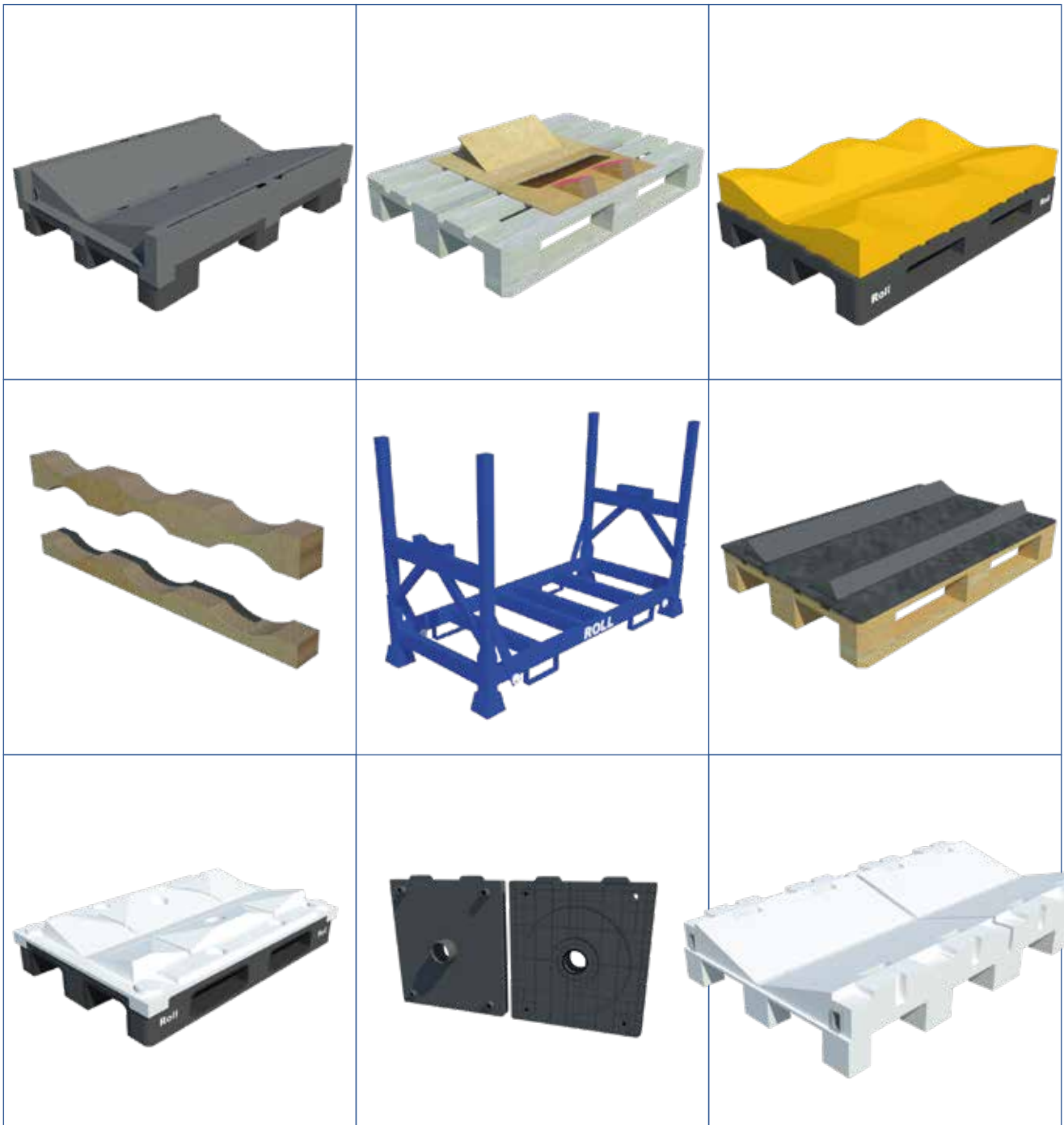

ROLL SNC - Via Don Capiaghi 9 - Bregnano (Como) - Italy



We are the **specialists**  
for **packaging, storage and transport solutions for**  
**industrial heavy rolls/reels.**

We design easy and innovative solutions, giving new life  
to recycled materials and solutions for intensive use.

**Concrete Circular Economy!**

Thanks our long experience and knowledge of this market  
our Team supports you to find the best solutions.

We are located in Italy (Milan area)  
and **we sell all over the world.**

ROLL...Experts for Roll Storage

**Contact us!**

We guarantee an answer in 24 hours

*Siamo gli specialisti per soluzioni per l'imballo, lo stoccaggio e il trasporto  
di rotoli e bobine pesanti a livello industriale.*

*Realizziamo soluzioni facili ma innovative, dando nuova vita a materiali  
riciclati e progettando soluzioni destinate a un uso intensivo.  
Per un'economia circolare concreta!*

*Grazie alla nostra lunga esperienza e conoscenza del settore il nostro Team  
vi supporta per trovare le migliori soluzioni.*

*Dall'Italia (area di Milano) vendiamo in tutto il mondo.  
ROLL. Gli esperti per le stoccaggio Bobine  
Contattaci! Garantiamo la risposta in 24h*



[www.roll-packaging.com](http://www.roll-packaging.com)  
[info@roll-packaging.com](mailto:info@roll-packaging.com)



**+39 339 208 2301**  
**WhatsApp Customer Care**

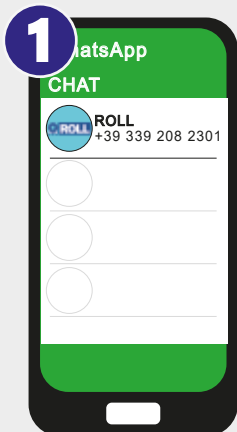

Open WhatsApp

Find ROLL contact  
(+39 339 208 2301)



Send your Pictures

What you're looking,  
what is your  
problem,  
actual situation,...

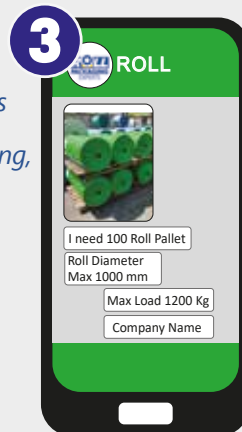

Send your message

Don't forget to write:  
1) Max Roll Diameter  
2) Max Roll Weight  
3) For Internal or External Use  
4) Nr Pieces Request  
3) Company Name

# **ROLL** catalogue

## **ROLL PALLET**

Warehouse  
Pallet Solutions



 **Pag. 4-10**

## **ROLL PALLET TRASFORMERS**

Convert Easily your Pallets  
to Roll Pallets

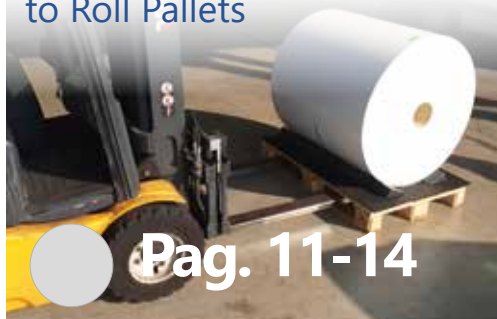

 **Pag. 11-14**

## **PLASTIC PALLETS BASE**

Basis for  
Roll Pallet Solutions



 **Pag. 15-16**

## **ROLL KUNEO**

Plastic Wedges  
alternative to Wood.



 **Pag. 17-18**

## **ROLL SUPPORTS PAPER MADE**

Paper Cradle, Paper Wedges

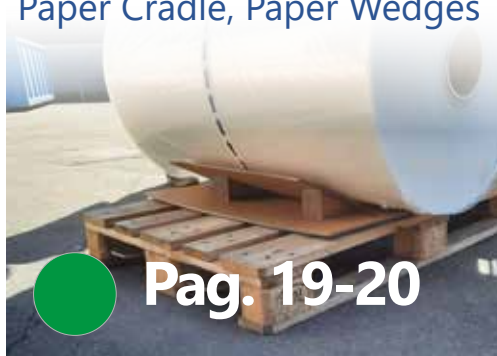

 **Pag. 19-20**

## **ROLL FLANGE**

Roll Storage in Suspension  
by Plastic EndWall



 **Pag. 21-22**

## **ROLL HANGO MOVABLE STORAGE**

Steel Rolls Racks



 **Pag. 23-24**

## **ROLL RECYCLO**

Cores Stripper  
Machine



**Pag. 25-26**



**Series of products  
100% recycled material. Designed by Roll  
according the logic of  
upcycling.**

*Serie di prodotti 100%  
materiale riciclato.  
Progettati da Roll secondo  
la logica dell'upcycling.*

**Series of products with  
virgin materials  
designed for food and  
pharmaceutical  
packaging industries.**

*Serie di prodotti con  
materiali vergini adatti  
all'industria del packaging  
alimentare e farmaceuti-  
co.*

**Series of unique and  
customizable products.  
Made with patented or  
exclusive technology.**

*Serie di prodotti unici e  
personalizzabili.  
Realizzati con tecnologia  
brevettata o esclusiva.*





(ENG) Roll Cradle Pallet  
 (ITA) Pallet per Bobine  
 (GER) Rollenpaletten  
 (FRA) Palettes pour Bobines  
 (ESP) Pallet para Bobinas

# ROLL PALLET

Warehouse Pallet Solutions

## INFO TO START

Collect this information and contact us!



**Max Roll Diameter ?**  
(mm)



**Max Roll Weight ?**  
(Kg)



**Pallets Storage ?**

- A) on the **Floor**
- B) on the **Shelves**



C) on **Rack**



**Pallets Use ?**

A) Internal

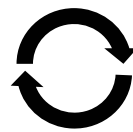

B) One-Way



**How many Pallets ?**



# ROLL PALLET euro for RACK

www.roll-packaging.com - info@roll-packaging.com

Roll Pallets with classic sizes 800x1200 mm.  
Suitable for storage on the floor or on shelves but  
also on the racks.  
Solutions for big warehouse of heavy rolls.

*Pallet porta rotoli dalle classiche dimensioni 800x1200.  
Adatti per stoccaggio a terra o su scaffale ma anche su rack.  
Soluzioni per grandi magazzini di rotoli e bobine pesanti.*



## ROLL PALLET RCV69

800x1200 - for rack - with steel reinforcement  
800 (w) x 1200 (l) x 275 (h) mm

**New!**



steel bars

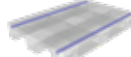

recyclate 100%



1400



1500



A+B



1200



800

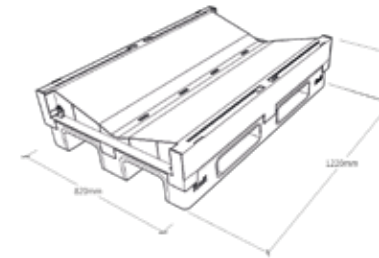

26 Kg/unit - 8 units/pack

## ROLL PALLET RP01

800x1200 - for rack  
800 (w) x 1200 (l) x 190 (h) mm



recyclate 100%



1200



2000



A+B



1200



1000

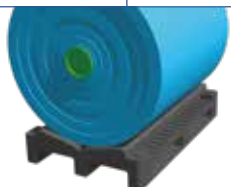
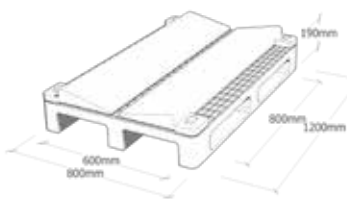

28 Kg/unit - 11 units/pack

## ROLL PALLET RCV49

800x1200 - deck virgin - for 1 or 2 rolls  
800 (w) x 1200 (l) x 190 (h) mm

Deck HDPE Virgin

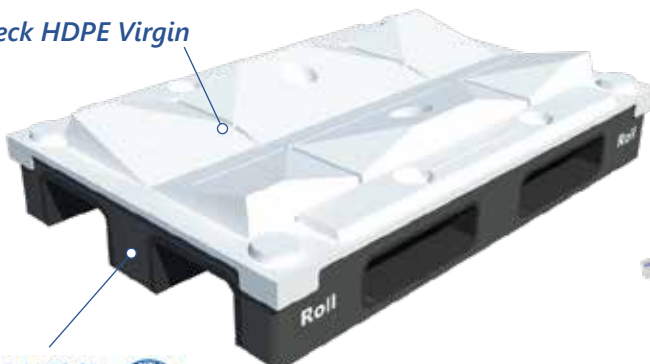

steel bars

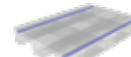

1100



1500



A+B



1200



1000

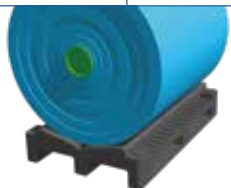

24 Kg/unit - 11 units/pack



\* Possibility to have Plastic Pallet H1 100% Virgin



# ROLL PALLET euro for RACK

www.roll-packaging.com - info@roll-packaging.com



## ROLL PALLET RC39-1

800x1200 - for rack - with Combo deck

800\* (w) x 1200 (l) x 275 (h) mm

\* possibility version 1000x1200 mm

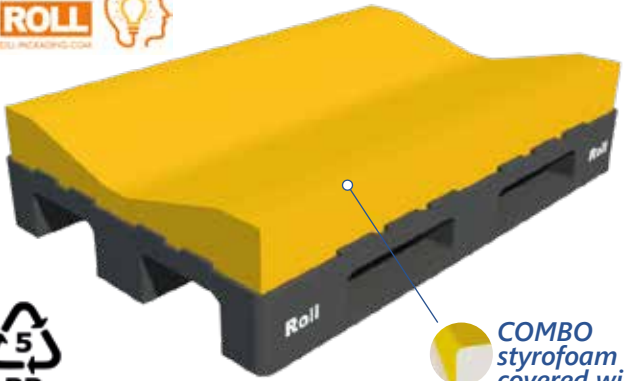

steel bars

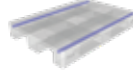

COMBO  
styrofoam super density  
covered with Polyurea



1100



1500



A+B



1200



1000

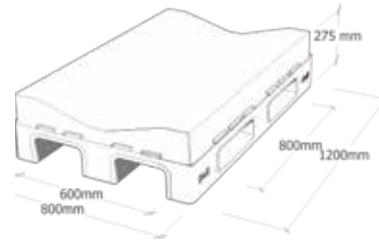

21 Kg/unit - 8 units/pack

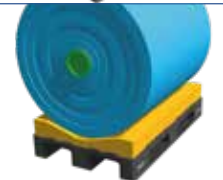

## ROLL PALLET RC39-2

800x1200 - with Combo deck - for 1 or 2 rolls

800\* (w) x 1200 (l) x 275 (h) mm

\* possibility version 1000x1200

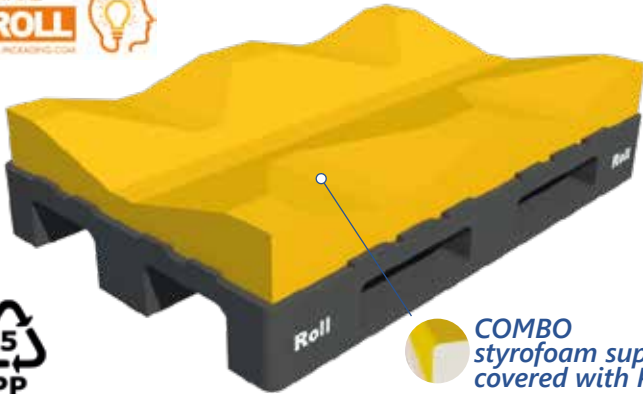

steel bars

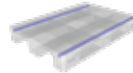

COMBO  
styrofoam super density  
covered with Polyurea



1100



1500



A+B



1200



1000

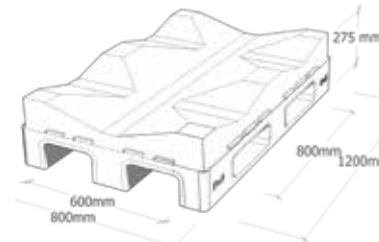

21 Kg/unit - 8 units/pack

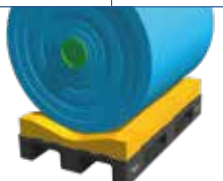

## ROLL PALLET RC39-1-L

800x1200 - with Combo deck

800 (w) x 1200 (l) x 295 (h) mm



steel bars

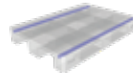

COMBO  
styrofoam super density  
covered with Polyurea



1300



1500

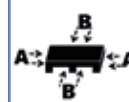

A+B



1200



800

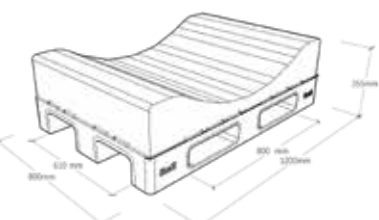

24 Kg/unit - 6 units/pack

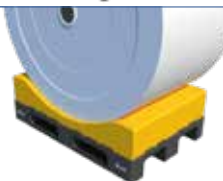

# ROLL PALLET small for FLOOR / SHELVES

www.roll-packaging.com - info@roll-packaging.com

Roll Pallet handled by hand forklift (2 or 4 ways).  
Perfect for rolls storage on the floor and on the shelves.  
Great variety of dimensions (S to XL)

*Pallet porta bobine/rotoli  
movimentabili anche con transpallet sulle 4 vie.  
Perfetti per stoccaggio di bobine a terra o su scaffali.  
Grande varietà di dimensioni (da S a XL).*



## ROLL PALLET RM01 800x740 - for rack - with steel reinforcement

800 (w) x 740 (l) x 220 (h) mm

**New!**

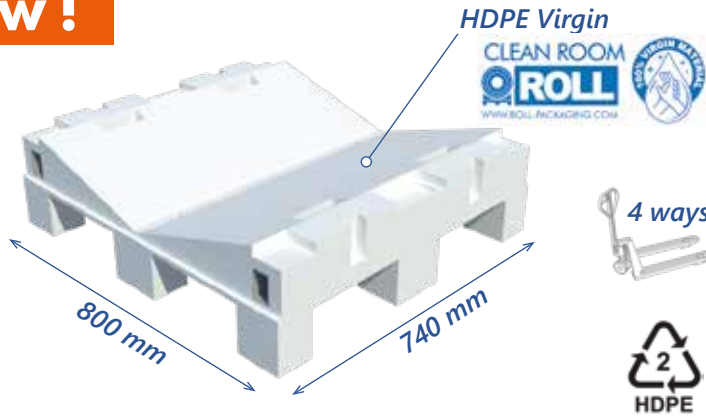

1400



800



A+B



800



-

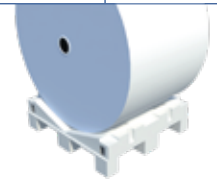
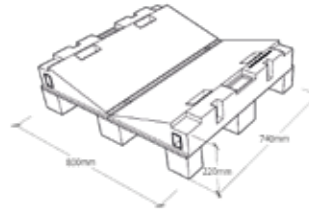

11 Kg/unit - 8 units/pack

## ROLL PALLET RP02 670x1000 - 4 ways - super strong

670 (w) x 1000 (l) x 129 (h) mm

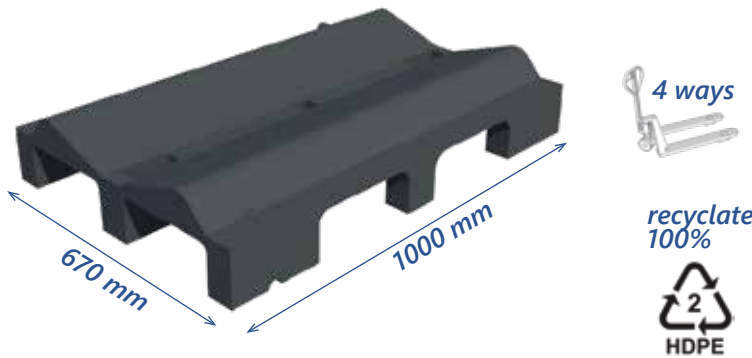

1000



2000



A+B



1200



-

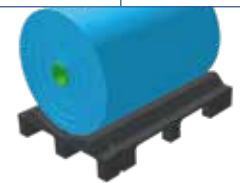
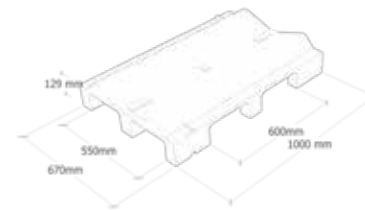

19.8 Kg/unit - 15 units/pack

## ROLL PALLET RP03 600x1000 - 2 ways - only for floor handling

600 (w) x 1000 (l) x 175 (h) mm



1100



1500



B



-



-

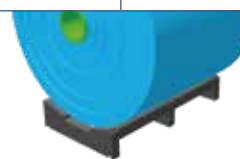
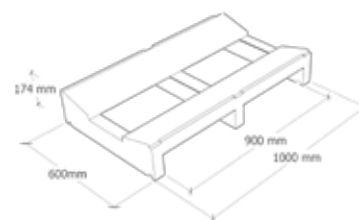

21 Kg/unit - 20 units/pack

# ROLL PALLET small for FLOOR / SHELVES

www.roll-packaging.com - info@roll-packaging.com



**ROLL PALLET RP12-80** 400x800 - 2 ways - only for floor handling  
400 (w) x 800 (l) x 150 (h) mm



700

1500

B

-

-

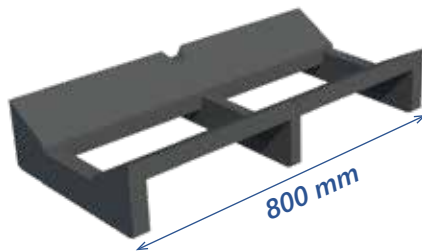

recyclate 100%

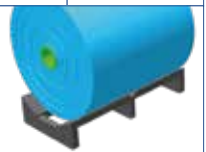
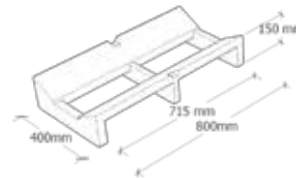

9.5 Kg/unit - 50 units/pack

**ROLL PALLET RP12-100** 400x1000 - 2 ways - only for floor handling  
400 (w) x 1000 (l) x 150 (h) mm

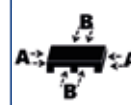

700

1500

B

-

-

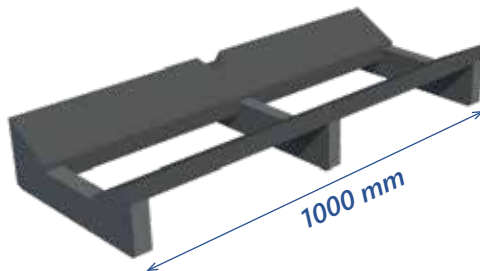

recyclate 100%

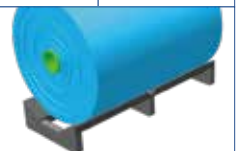
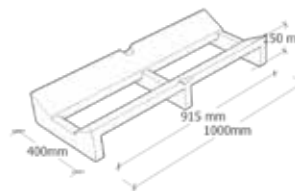

10.5 Kg/unit - 50 units/pack

**ROLL PALLET RP12-120** 400x1200 - 2 ways - only for floor handling  
400 (w) x 1200 (l) x 150 (h) mm



700

1500

B

-

-

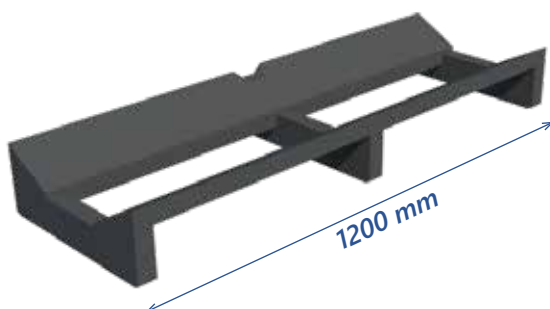

recyclate 100%

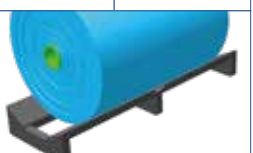
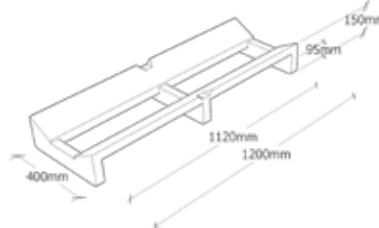

12 Kg/unit - 40 units/pack



# ROLL PALLET m-xl for FLOOR / SHELVES

www.roll-packaging.com - info@roll-packaging.com



**ROLL PALLET RCV28** 800x1200 - 4 ways - only for floor handling  
800 (w) x 1200 (l) x 270 (h) mm

**New !**



recyclate 100%



1400



1200



A+B



800



-

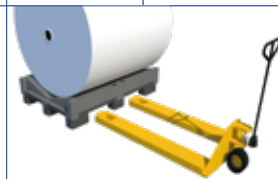
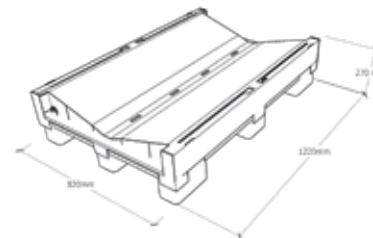

32 Kg/unit - 8 units/pack

**ROLL PALLET RCV08** 800x1200 - 4 ways - for 1 or 2 rolls  
800 (w) x 1200 (l) x 190 (h) mm

Deck HDPE Virgin



4 ways



\* Possibility to have Plastic Pallet 9 Feet 100% Virgin



1100



1500



A+B



800



-

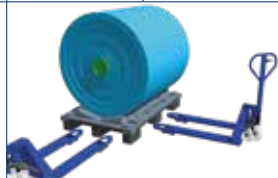
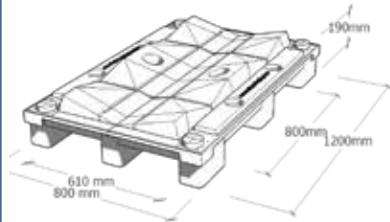

26 Kg/unit - 11 units/pack

**ROLL PALLET COPA-80-160** 800x1600 - Combo - only for floor handling  
800\* (w) x 1600 (l) x 340 (h) mm  
\* possibility version 1000x1600 mm

1600 mm

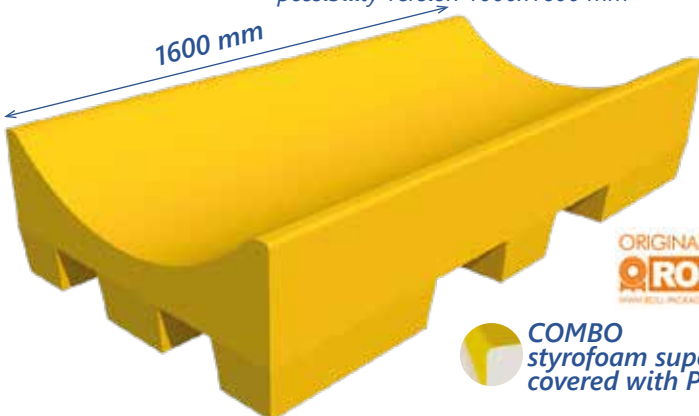

COMBO styrofoam super density covered with Polyurea



1000



800



B



-



-

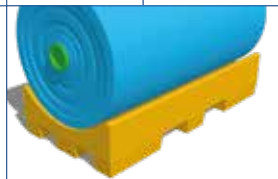
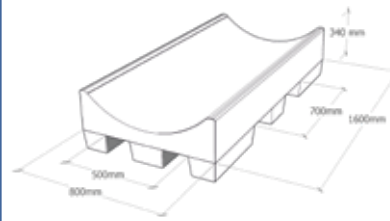

10 Kg/unit - 6 units/pack

# ROLL PALLET xl for FLOOR / SHELVES

www.roll-packaging.com - info@roll-packaging.com



**ROLL PALLET RM02** 800x1480 - 4 ways - with steel reinforcement  
800 (w) x 1480 (l) x 220 (h) mm

**New !**

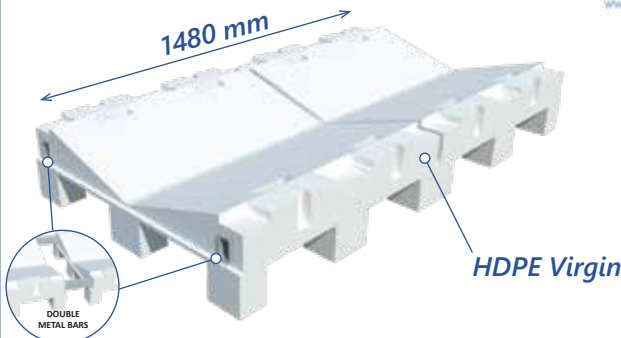

1400	1500	A+B	1000	-

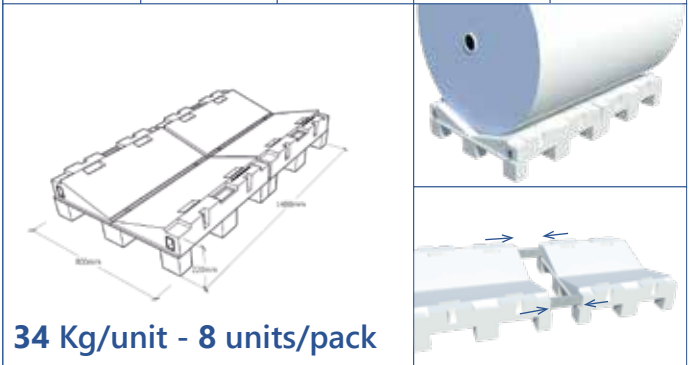

34 Kg/unit - 8 units/pack

**ROLL PALLET RM03** 800x1480 - 4 ways - with steel reinforcement  
800 (w) x 2220 (l) x 220 (h) mm

**New !**

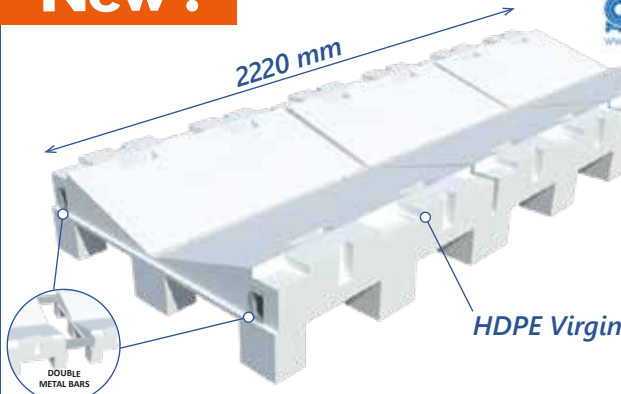

1400	1800	B	1200	-

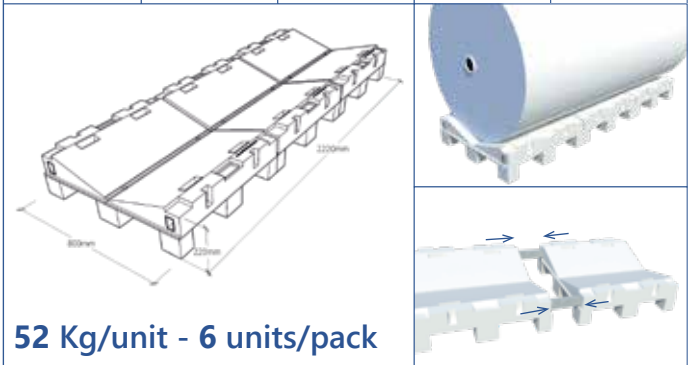

52 Kg/unit - 6 units/pack

**ROLL PALLET RCX-80-240** 800x2360 - with Combo Deck  
800 (w) x 2360 (l) x 305 (h) mm

**New !**

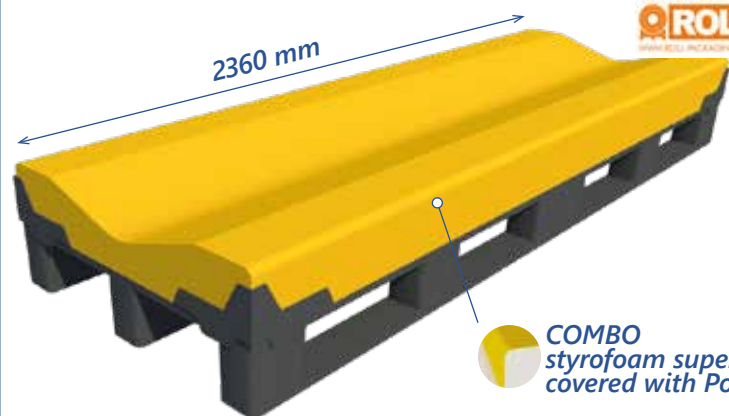

800	1000	B	-	-

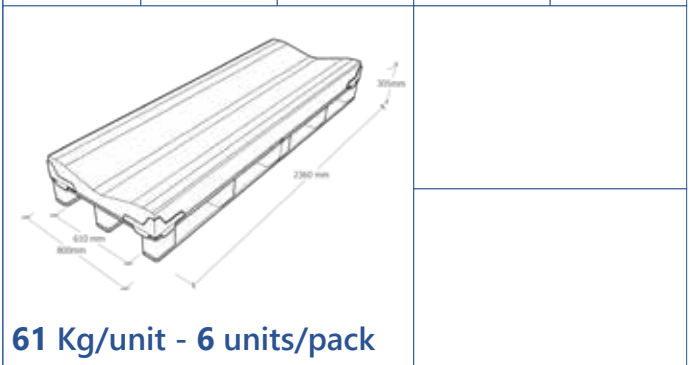

61 Kg/unit - 6 units/pack



(ENG) Roll Cradle Pallet Trasformers  
 (ITA) Soluzioni per trasformare  
 in Pallet Porta Bobine  
 (GER) Transformatoren  
 ein Rollenpaletten  
 (FRA) Transformateurs  
 en Palettes pour Bobines  
 (ESP) Transformadores  
 en Pallet para Bobinas









# ROLL PALLET TRASFORMERS

Convert Easily your Pallets to Roll Pallets

## INFO TO START

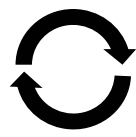
Collect this information and contact us!

<p><b>?</b>  <b>Max Roll Diameter ?</b>                  (mm)</p> 	<p><b>?</b>  <b>Max Roll Weight ?</b>                  (Kg)</p> 	<p><b>?</b>  <b>Pallets Storage ?</b>                  A) on the <b>Floor</b>                  B) on the <b>Shelves</b></p>  <p>C) on <b>Rack</b></p> 	<p><b>?</b>  <b>Pallets Use ?</b>                  A) Internal</p>  <p>B) One-Way</p> 	<p><b>?</b>  <b>How many Pallets ?</b></p> 
---	---	--	--	--



# ROLL STABILO for LOAD by ROLLING

www.roll-packaging.com - info@roll-packaging.com

Transform your wooden or plastic pallets into roll palettes with **incredible stability!**

*Trasforma i tuoi pallet in legno o in plastica in pallet porta rotoli con una stabilità incredibile!*



## ROLL STABILO SB01-KIT

800x1200 rubber mat + 2x wedges KU04-570  
800 (w) x 1200 (l) x 60 (h) mm

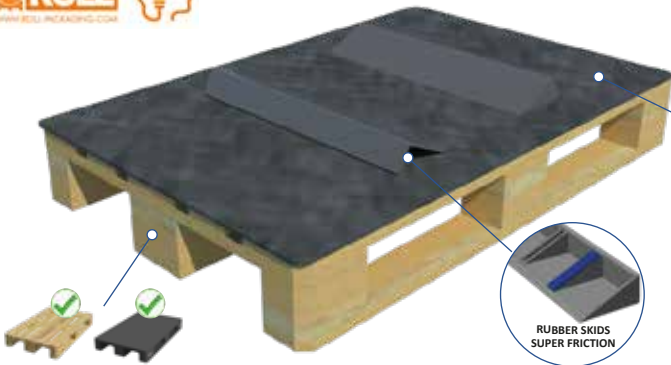

rubber mat  
antislip

recyclate  
100%



RUBBER SKIDS  
SUPER FRICTION



1100



2000

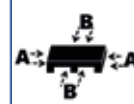

Depending  
Pallet



Depending  
Pallet



Depending  
Pallet



$$SB01 = ( 1x RPMT + 2x KU04-570 )$$

10 Kg/unit - 80 units/pack

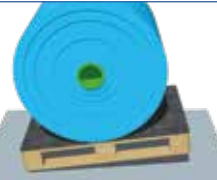
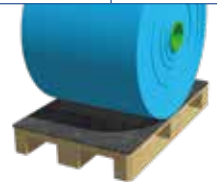

## ROLL STABILO SB02-KIT

800x1200 rubber mat + 2x wedges KU04-1143  
800 (w) x 1200 (l) x 60 (h) mm

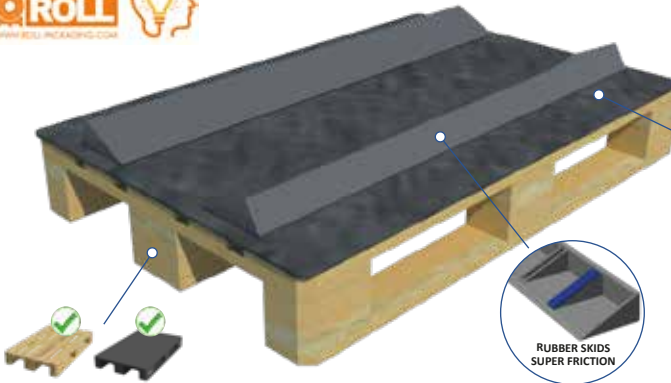

rubber mat  
antislip

recyclate  
100%



RUBBER SKIDS  
SUPER FRICTION



1100



2000



Depending  
Pallet



Depending  
Pallet



Depending  
Pallet



$$SB02 = ( 1x RPMT + 2x KU04-1143 )$$

12 Kg/unit - 80 units/pack

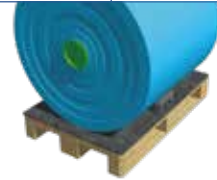

## ROLL STABILO SB03-KIT

800x1200 rubber mat + 2x wedges KU01+  
800 (w) x 1200 (l) x 80 (h) mm



rubber mat  
antislip

recyclate  
100%



SAFE HANDS

RUBBER SKIDS  
SUPER FRICTION



1200



1500



Depending  
Pallet



Depending  
Pallet



Depending  
Pallet

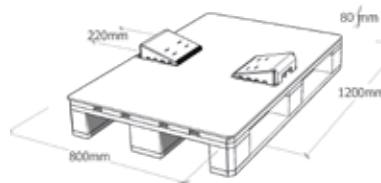

$$SB03 = ( 1x RPMT + 2x KU01+ )$$

12 Kg/unit - 80 units/pack

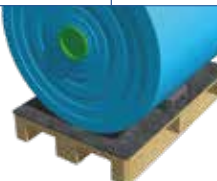

# ROLL CONVERTO PALLET DECKS

www.roll-packaging.com - info@roll-packaging.com

Transform your wooden or plastic pallets to roll pallets easily by placing the **Covertto Decks!**

*Trasforma i tuoi pallet in legno o in plastica in pallet porta rotoli semplicemente appoggiando i Deck Converto!*

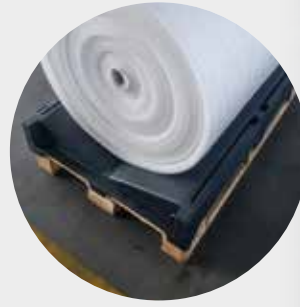

**ROLL CONVERTO** 800x1200 deck  
**CV02**

800 (w) x 1200 (l) x 175 (h) mm

**New!**



1400



1000



Depending Pallet



Depending Pallet



Depending Pallet

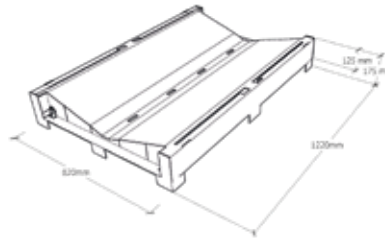

12 Kg/unit - 10 units/pack



**ROLL CONVERTO** 800x1200 deck virgin - for 1 or 2 rolls  
**CV01**

800 (w) x 1200 (l) x 100 (h) mm

Deck HDPE Virgin

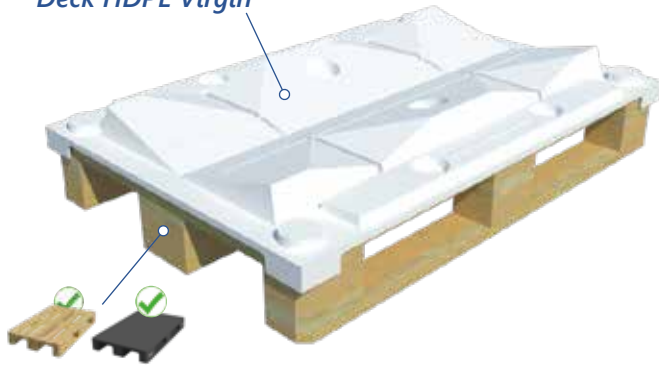

1100



1500



Depending Pallet



Depending Pallet



Depending Pallet



7 Kg/unit - 28 units/pack



Roll Converto is the easiest way to make large Rolls Warehouse with a low budget



www.roll-packaging.com - info@roll-packaging.com



# ROLL COMBO PALLET DECKS

Transform your wooden to roll pallets easily by placing the **Combo Decks** - not hard surface!

*Trasforma i tuoi pallet in legno o in plastica in pallet porta rotoli semplicemente appoggiando i Deck Combo - superficie non dura!*

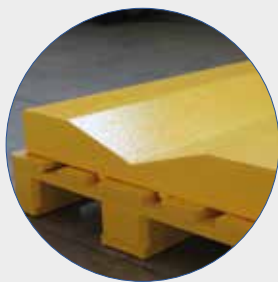

## ROLL COMBO CO01-W

800x1200 Combo Deck

**800 (w) x 1200 (l) x 120 (h) mm\***  
\* possibility to have tailor made dimensions

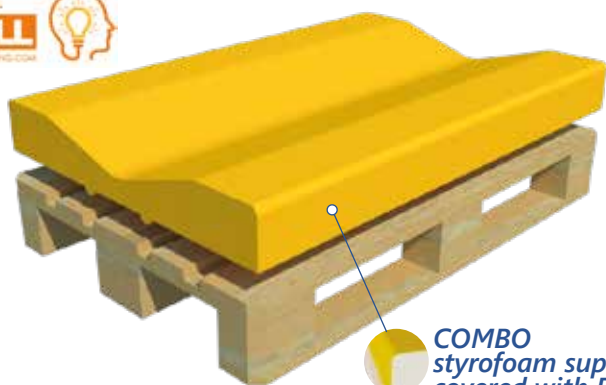

**COMBO**  
styrofoam super density  
covered with Polyurea



1100



800



Depending  
Pallet



Depending  
Pallet



Depending  
Pallet

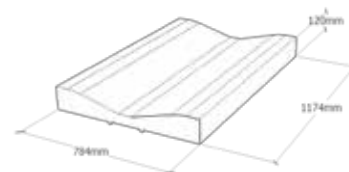

**3.6 Kg/unit - 16 units/pack**

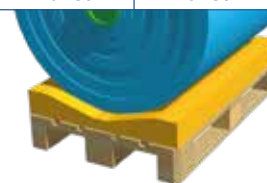

## ROLL COMBO CO02-W

800x1200 Combo Deck - for 1 or 2 rolls

**800 (w) x 1200 (l) x 120 (h) mm\***  
\* possibility to have tailor made dimensions

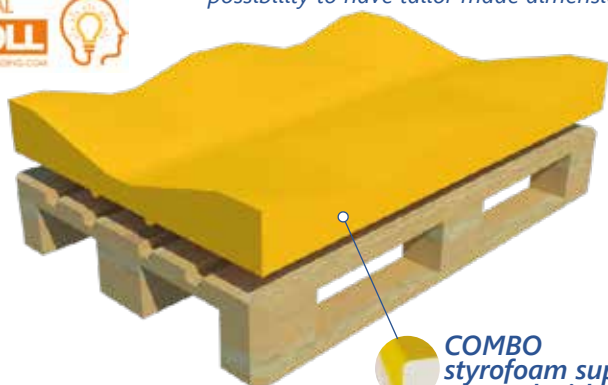

**COMBO**  
styrofoam super density  
covered with Polyurea



1100



800

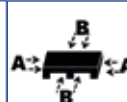

Depending  
Pallet



Depending  
Pallet



Depending  
Pallet



**3.6 Kg/unit - 16 units/pack**



Roll Combo is exclusive technology that allows you to design cradle with **customized shapes and sizes**.

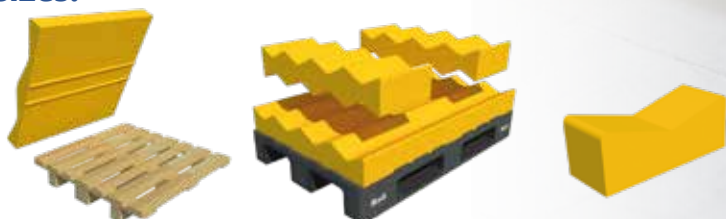









(ENG) Plastic Pallet Base  
 (ITA) Pallet in Plastica Base  
 (GER) Kunststoff-Basispalette  
 (FRA) Palette de base en Plastique  
 (ESP) Paleta ase de Plástico

# PLASTIC PALLETS BASE

Pallets of different Resistances  
like a Basis for Roll Pallet Solutions

## INFO TO START

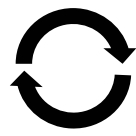
Collect this information and contact us!

<p><b>!</b> Differences between <b>Pallet Load Resistance</b> and <b>Roll Pallet Load Resistance</b></p> <div style="display: flex; justify-content: space-around;"> <div style="text-align: center;"> <p><b>Pallet Static Load</b></p>  <p>distributed</p> </div> <div style="text-align: center;"> <p><b>!</b></p> </div> <div style="text-align: center;"> <p><b>Roll Pallet Load</b></p>  <p>localized</p> </div> </div>	<p><b>?</b> <b>Pallets Storage ?</b></p> <p>A) on the <b>Floor</b>              B) on the <b>Shelves</b></p>  <p>C) on <b>Rack</b></p> 	<p><b>?</b> <b>Pallets Use ?</b></p> <p>A) Internal</p>  <p>B) One-Way</p> 	<p><b>?</b> <b>How many Pallets ?</b></p> 
---	---	---	---

## PLASTIC PALLET LIGHT PP13

800 (w) x 1200 (l) x 120 (h) mm



7 Kg/unit - 20 units/pack

Max kg	Max kg	Max kg
2000	1000	200

## PLASTIC PALLET LIGHT PP23

800 (w) x 1200 (l) x 155 (h) mm



11 Kg/unit - 15 units/pack

Max kg	Max kg	Max kg
4000	1200	300



## PLASTIC PALLET MEDIUM PP69

800 (w) x 1200 (l) x 155 (h) mm



14.5 Kg/unit - 15 units/pack

Max kg	Max kg	Max kg
5000	1250	1000

## PLASTIC PALLET MEDIUM PP39

800 (w) x 1200 (l) x 158 (h) mm



18.2 Kg/unit - 15 units/pack

Max kg	Max kg	Max kg
5000	1500	1200

## PLASTIC PALLET MEDIUM PP49

800 (w) x 1200 (l) x 155 (h) mm



16 Kg/unit - 15 units/pack

Max kg	Max kg	Max kg
5000	1500	1200

## PLASTIC PALLET HEAVY PP03

800 (w) x 1200 (l) x 155 (h) mm



25 Kg/unit - 15 units/pack

Max kg	Max kg	Max kg
6000	1500	500

## PLASTIC PALLET HEAVY PP08

800 (w) x 1200 (l) x 140 (h) mm



19 Kg/unit - 15 units/pack

Max kg	Max kg	Max kg
5000	1500	-

## PLASTIC PALLET HEAVY PP09

800 (w) x 1200 (l) x 155 (h) mm



28 Kg/unit - 15 units/pack

Max kg	Max kg	Max kg
6000	1500	1200



*(ENG)* Plastic Roll Wedges  
*(ITA)* Cunei in Plastica per Bobine  
*(GER)* Kunststoffkeile  
*(FRA)* Cales pour Bobines  
*(ESP)* Cuñas

# ROLL KUNEO

Wedge alternative to Wood Wedges.  
Super Reusable and Safe.



## ROLL KUNEO KU04-570

150 (w) x 570 (l) x 50 (h) mm

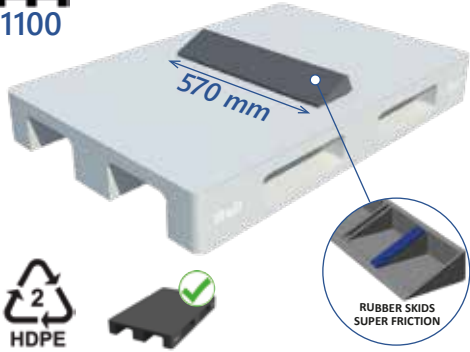

1 Kg/unit - 100 units/pack

## ROLL KUNEO KU04-1143

150 (w) x 1143 (l) x 50 (h) mm

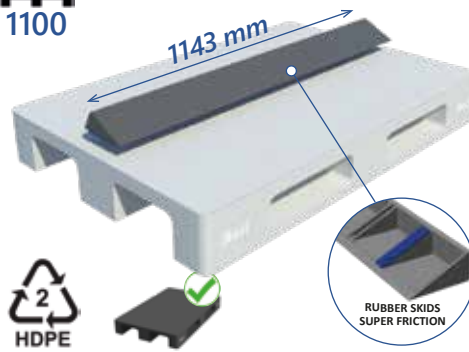

2.1 Kg/unit - 60 units/pack



## ROLL KUNEO KU01

220 (w) x 220 (l) x 75 (h) mm



0.5 Kg/unit - 192 units/pack

## ROLL KUNEO KU01 +

220 (w) x 220 (l) x 75 (h) mm

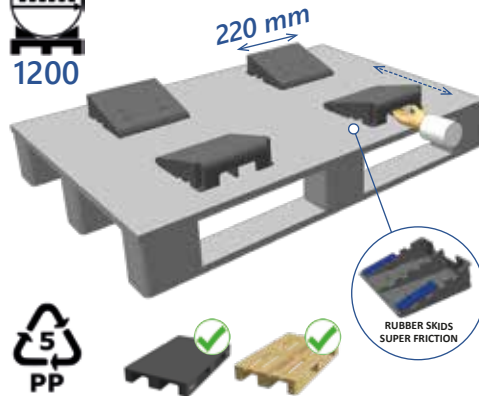

0.6 Kg/unit - 192 units/pack

## ROLL KUNEO KU012

220 (w) x 220 (l) x 75 (h) mm



1.3 Kg/unit - 96 units/pack

## ROLL KUNEO KU06

130 (w) x 160 (l) x 80 (h) mm



0.5 Kg/unit - 90 units/pack





(ENG) Paper Cradle et Wedges  
 (ITA) Selle e Cunei in Cartone  
 (GER) Kartonwiege und Kartonkeile  
 (FRA) Selles et Cales en Carton  
 (ESP) Monturas y Cuñas de Cartón

# ROLL SUPPORTS PAPER MADE

Paper Cradle, Saddle and Wedges

**ROLL STABILO  
 SBP01**

700x616 carton mat + 4x carton wedges

700 (w) x 616 (l) x 80 (h) mm

**New !**

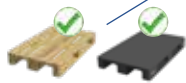
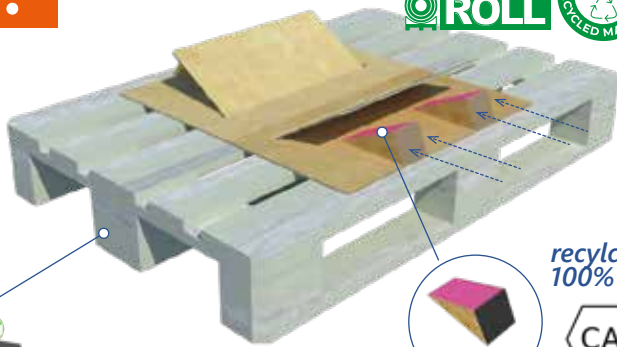

recyclate 100%



SBP01 = 1x MAT + 4x WEDGES

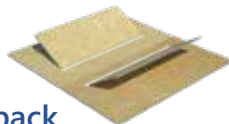

0.5 Kg/unit - 60 units/pack





## ROLL STICKO PAPER PC02-580



140 (w) x 1160 (l) x 80 (h) mm

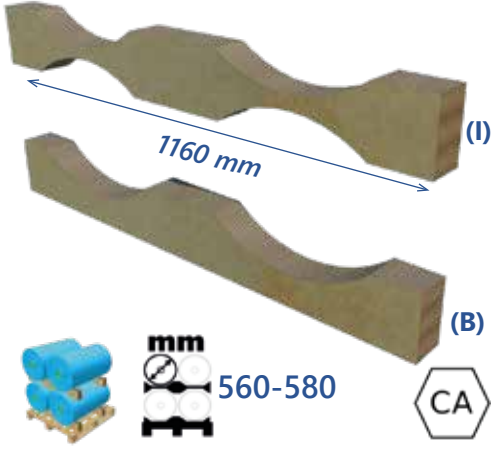

(B) 70 units/pack - (I) 70 units/pack

## ROLL STICKO PAPER PC02-500



120 (w) x 1000 (l) x 80 (h) mm

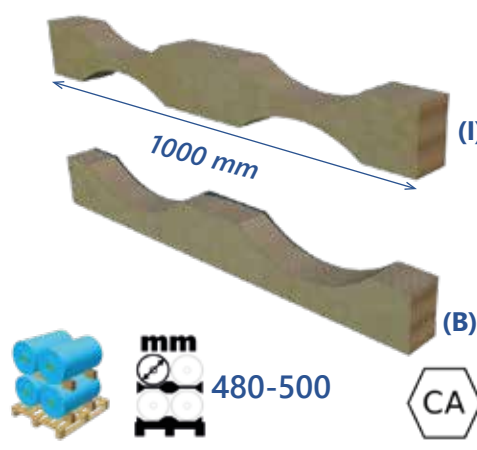

(B) 80 units/pack - (I) 80 units/pack

## ROLL STICKO PAPER PC02-400



90 (w) x 800 (l) x 80 (h) mm

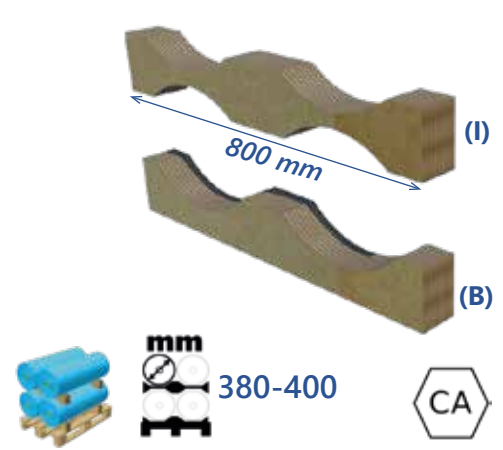

(B) 70 units/pack - (I) 70 units/pack

## ROLL STICKO PAPER PC03-400



90 (w) x 1200 (l) x 80 (h) mm

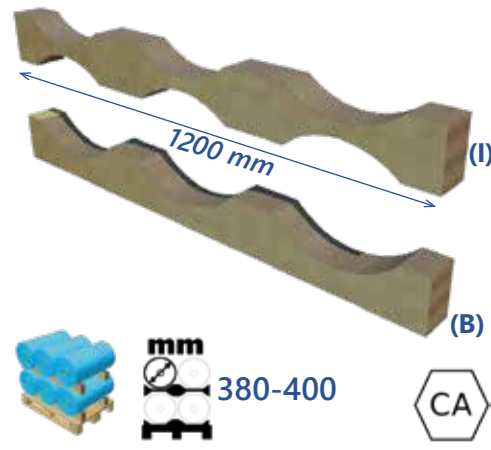

(B) 70 units/pack - (I) 70 units/pack

## ROLL STICKO PAPER PC03-300



120 (w) x 920 (l) x 80 (h) mm

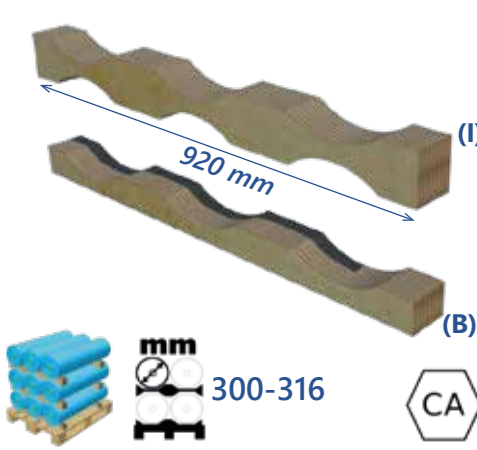

(B) 220 units/pack - (I) 120 units/pack

## ROLL STICKO PAPER PC04-250



90 (w) x 1060 (l) x 80 (h) mm

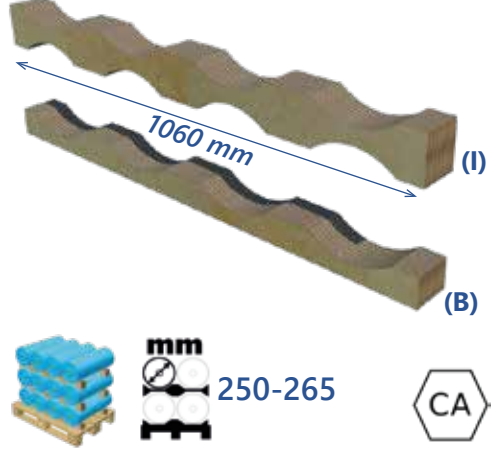

(B) 220 units/pack - (I) 130 units/pack

## ROLL STICKO PAPER PC04-230



90 (w) x 980 (l) x 80 (h) mm

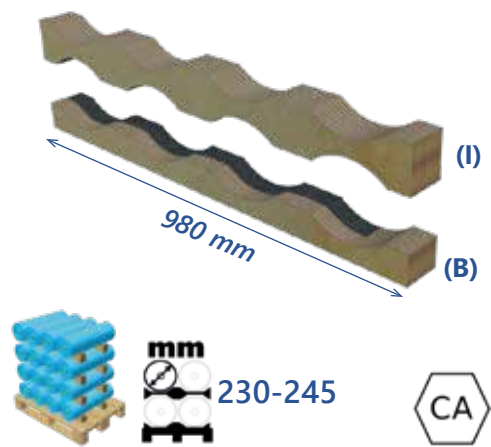

(B) 220 units/pack - (I) 130 units/pack

## ROLL STICKO PAPER PC05-200



120 (w) x 1080 (l) x 80 (h) mm

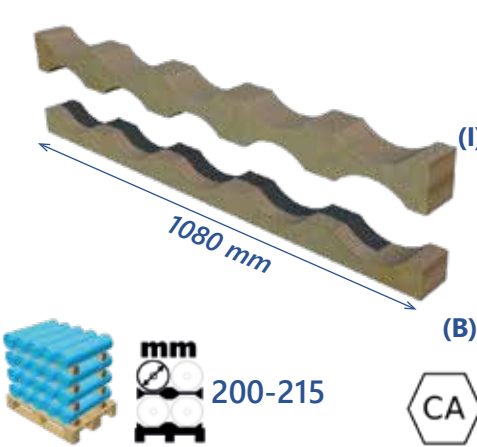

(B) 220 units/pack - (I) 130 units/pack

## ROLL STICKO PAPER PC06-160



90 (w) x 1050 (l) x 80 (h) mm

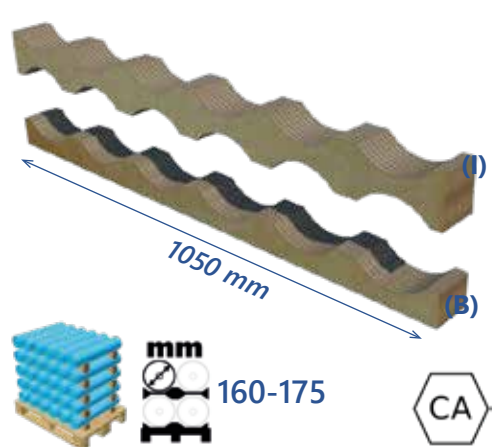

(B) 220 units/pack - (I) 130 units/pack



(ENG) Plastic EndWal  
(ITA) Flange Porta Bobine in Plastica  
(GER) Kunststoffflansche  
(FRA) Flasques en Plastique  
(ESP) Bridas de Plasticos

# ROLL FLANGE END PLATE FOR STORAGE

Roll Storage in Suspension by Plastic EndWall

## HOW TO ASSEMBLY

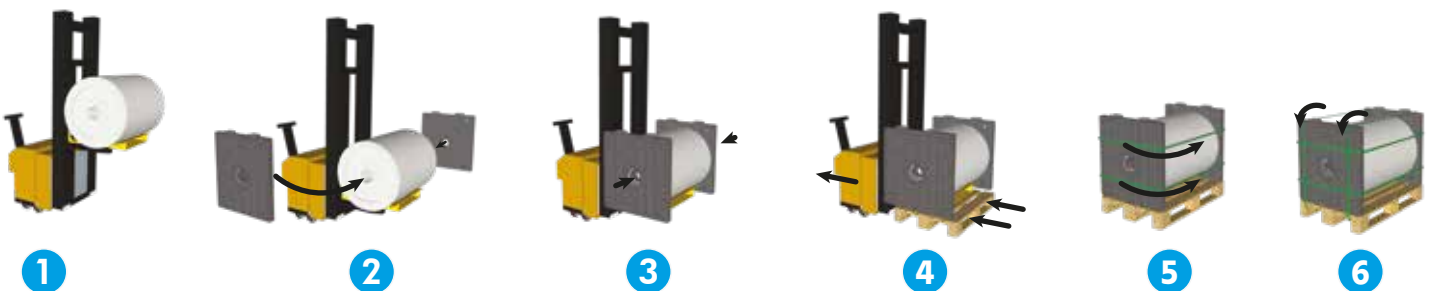



## ROLL FLANGE FL01\*

330 (w) x 330 (l) x 30 (h) mm



330



150



\*FL01-76 (Plug 3" - 76 mm)  
\*FL01-152 (Plug 6" - 152 mm)  
270 units/pack



## ROLL FLANGE FL02\*

510 (w) x 500 (l) x 40 (h) mm



500



400



\*FL02-76 (Plug 3" - 76 mm)  
\*FL02-152 (Plug 6" - 152 mm)  
100 units/pack

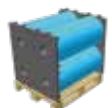

## ROLL FLANGE FL03\*

600 (w) x 580 (l) x 40 (h) mm



580



550



\*FL03-76 (Plug 3" - 76 mm)  
\*FL03-152 (Plug 6" - 152 mm)  
100 units/pack

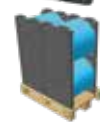

## ROLL FLANGE FL04

620 (w) x 600 (l) x 40 (h) mm



600



600



FL04-152 (Plug 6" - 152 mm)  
100 units/pack



## ROLL FLANGE FL05

700 (w) x 700 (l) x 50 (h) mm



680



800

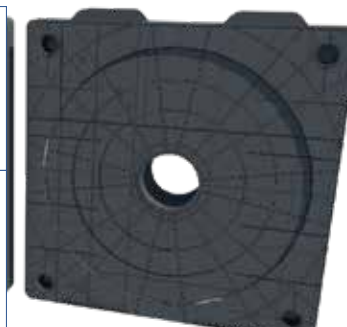

FL05-152 (Plug 6" - 152 mm)  
50 units/pack

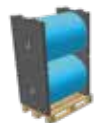

## ROLL FLANGE FL06

840 (w) x 800 (l) x 60 (h) mm



800



850

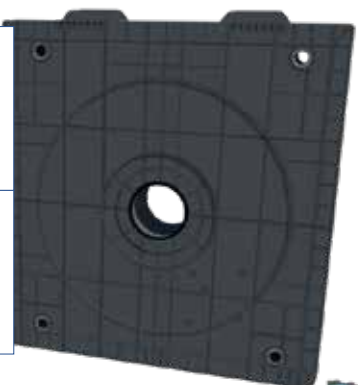

FL06-152 (Plug 6" - 152 mm)  
25 units/pack



## ROLL FLANGE FL06S

840 (w) x 800 (l) x 60 (h) mm



800



dep. PLUG

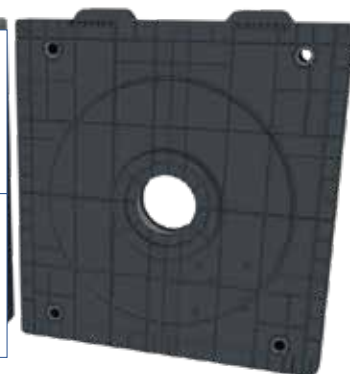

FL06S - NO PLUG  
35 units/pack

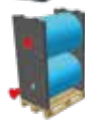

## ROLL FLANGE FL07

1040 (w) x 1000 (l) x 60 (h) mm



1000



dep. PLUG

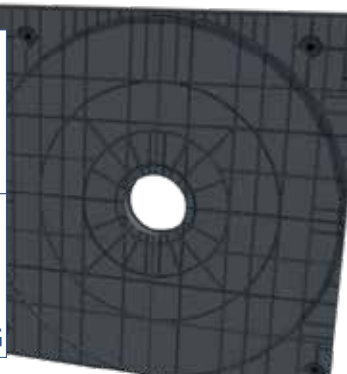

FL07 - NO PLUG  
30 units/pack



## ROLL PLUG PL01

Diam 76 x 90 (l) mm

350 Kg

2304 units/pack



## ROLL PLUG PL06

Diam 152 x 160 (l) mm

1250 Kg

288 units/pack



## ROLL PLUG PL07

Diam 152 x 165 (l) mm

1250 Kg

288 units/pack



(ENG) Steel Roll Racks  
(ITA) Trespoli per Bobine  
(GER) Metallpaletten für Rollen  
(FRA) Supports à Rouleaux en Acier  
(ESP) Bastidores de Rollos de Acero

# HANGO MOVABLE ROLLS STORAGE

Steel Pallet for Versatile Roll Storage



## ! DUAL USE

### 1) Suspension Roll Storage

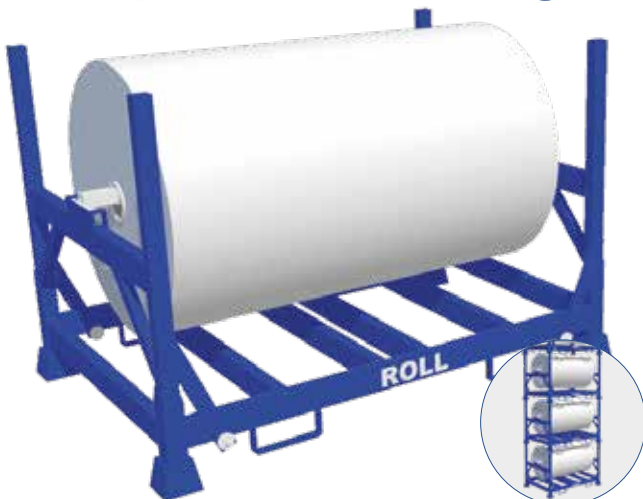

### 2) Roll Pallet Rack

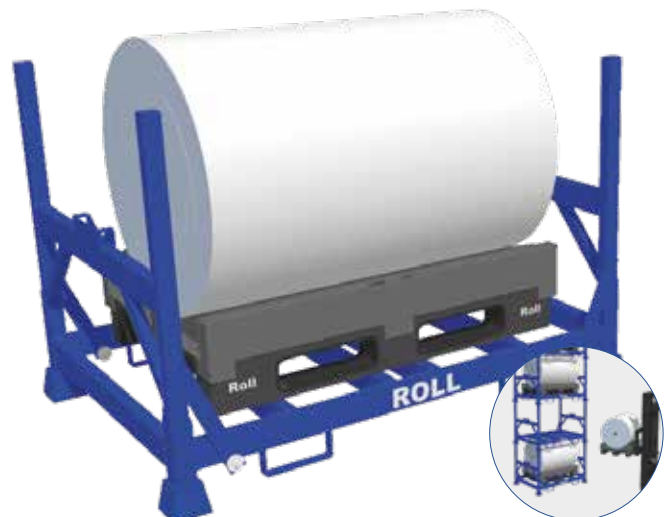



## ROLL HANGO HA160-75

**New !**

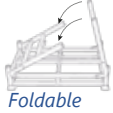

Foldable

## ROLL HANGO HA160-110

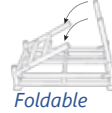
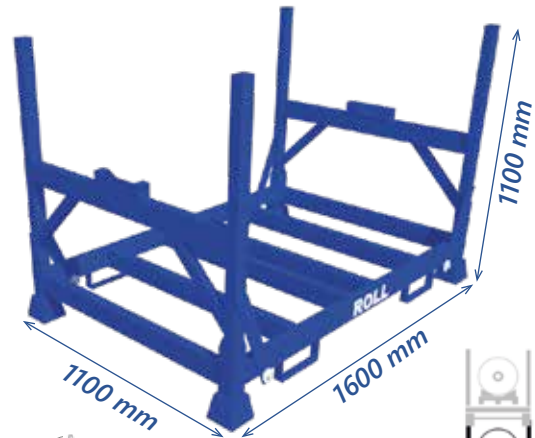

Foldable

## ROLL HANGO HA210-75

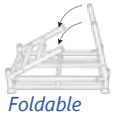
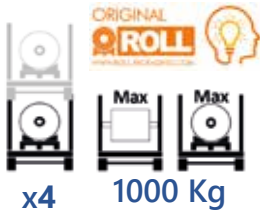
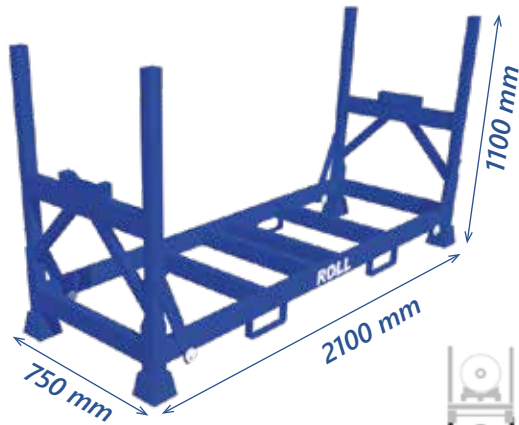

Foldable

## ROLL HANGO HA210-110

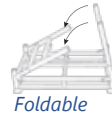
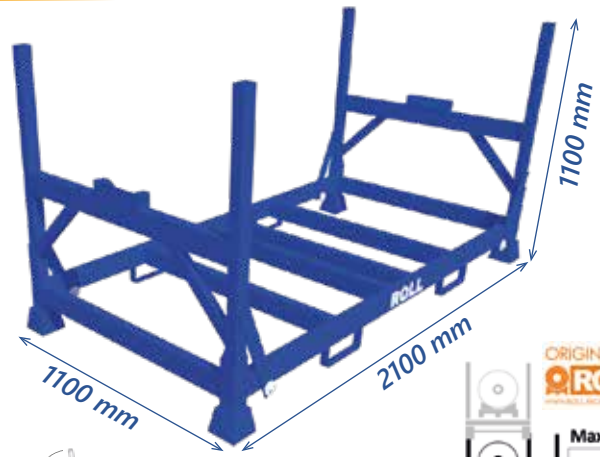

Foldable

Move your Rolls Rack Warehouse where you want!



Roll Rack Foldable (Easily!)



Dimensions designed for Shipping Optimization.

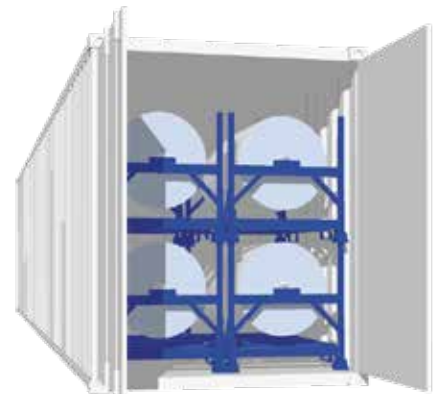

HA 210-75  
HA 160-75



HA 210-110  
HA 160-110

International Patent Pending



# RECYCLO

## CORE STRIPPER MACHINE

a partnership with



**A new machine with small dimensions, very easy to use that allows to separate the material from the cores from the end rolls.**

**In this way the wrapped material (plastic, paper or flexible materials) can be easily recycled and enhanced, while the spindle can be reused and disposed of separately.**

**The machine makes recycling and reuse easy with a view to a concrete circular economy.**

*Una macchina dalle dimensioni ridotte, facilissima da usare che permette di separare nei fine bobina il materiale dal mandrino.*

*In questo modo il materiale avvolto (plastica, carta o materiali flessibili) può essere facilmente riciclato e valorizzato, mentre il mandrino può essere riutilizzato e smaltito separatamente.*

*La macchina rende facile il riciclo e riutilizzo nell'ottica di una economia circolare concreta.*





### PLASTIC FILM

end roll



### PAPER

end roll

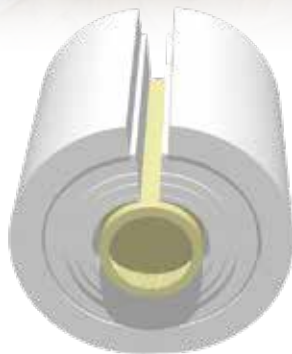

### ALUMINUM or COATED FILM

end roll

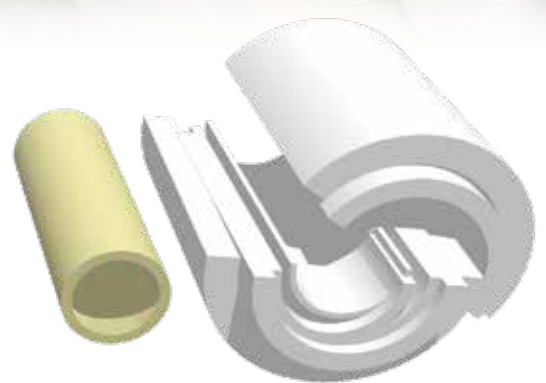

#### TECHNICAL DATA SHEET

Minimum Core Diameter (mm)	76 mm / 3"
Max Core Diameter (mm)	304 mm / 12"
Max Roll External Diameter (mm)	600 mm
Max Material Thickness to be Removed	100 mm
Max Roll Length (mm)	1500* mm/ 2500** mm
Max Roll Weight (Kg)	150 Kg
Roll Loading	Manual
Roll Unloading	Manual
Material Unloading	By Removable Carriage
Machine Length (mm)	2644 (mm)
Machine Width (mm)	824 (mm)
Machine Height (mm)	1552 (mm)
Machine Weight (Kg)	680(Kg)
Installed Power (kW)	0.8 (kW)
HMI	Asem Touch screen 7" router VPN integrated optional
PLC	Panasonic

Easy Solution for  
your New **Rolls Warehouse?**



**NO!**

 **ROLL YES!**



Convento  
**CV02**

Roll Pallet Size **XXL?**



**NO!**

 **ROLL YES!**

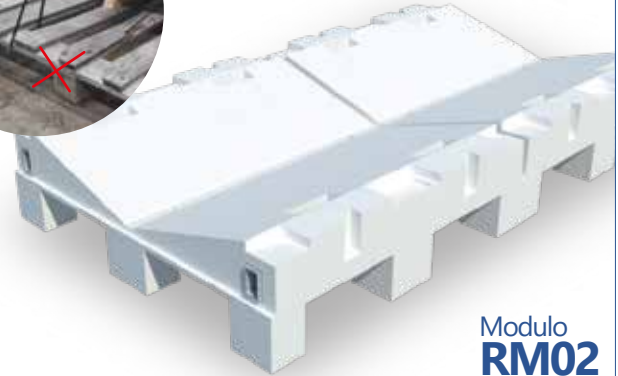

Modulo  
**RM02**

Wedges for Roll Pacakging?



**NO!**

 **ROLL YES!**

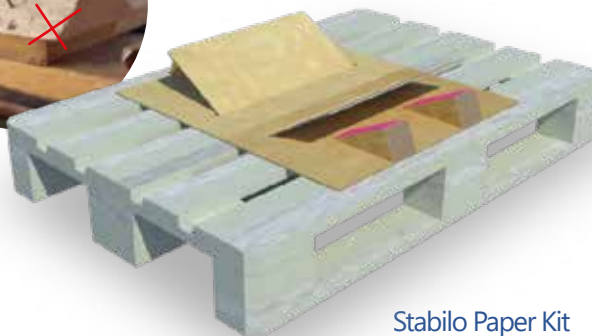

Stabilo Paper Kit  
**SBP01**

Roll Pallet for Clean Room?



**NO!**

 **ROLL YES!**

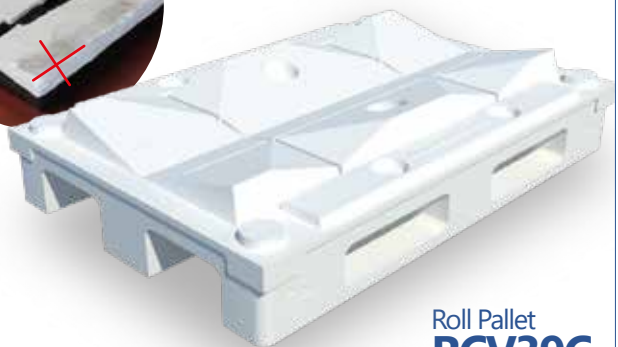

Roll Pallet  
**RCV39C**

Cradles for Roll  
packaging optimization?



**NO!**

 **ROLL YES!**

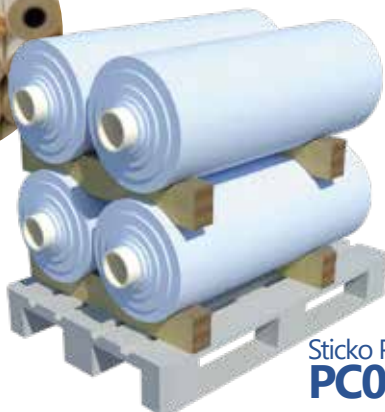

Sticko Paper  
**PC02-400**

... new products  
are coming!



# Roll Packaging, Handling and Storage Experts



# ROLL

**ROLL SNC**

Via Don Capiaghi 9  
22070 Bregnano (Como)  
Italy

VAT IT 0381 825 0130



[info@roll-packaging.com](mailto:info@roll-packaging.com)



+39 339 208 2301

[www.roll-packaging.com](http://www.roll-packaging.com)

